

LITHIUM IRON PHOSPHATE BATTERY

ELECTRICAL SPECIFICATIONS

Nominal Voltage	12.8 V
Nominal Capacity	75 Ah
Capacity @ 0.2C	>290 min
Energy	960 Wh
Resistance	<50 mΩ
Efficiency	99%
Self Discharge	<3% per Month
Maximum Modules in Series	4

DISCHARGE SPECIFICATIONS

Maximum Continuous Discharge Current	75 A
Peak Discharge Current	150 A
Recommended Low Voltage Disconnect	11 V
PCM Discharge Voltage Cut-Off	10 V
Reconnect Voltage	12 V
Short Circuit Protection	Yes

TEMPERATURE SPECIFICATIONS

Discharge Temperature	-20 to 60 °C
Charge Temperature	-20 to 60 °C
Storage Temperature	-20 to 60 °C
PCM High Temperature Cut-Off	176 °F (80 °C)

DIMENSIONAL SPECIFICATIONS

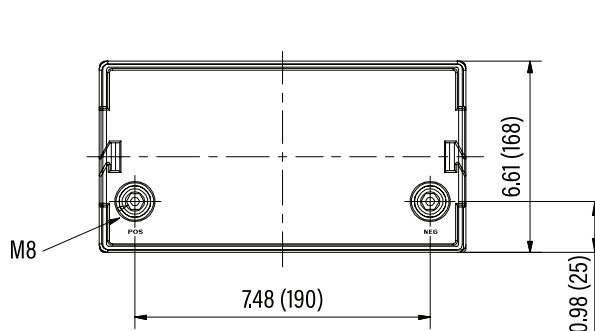

MECHANICAL SPECIFICATIONS

Dimensions (L x W x H)	260 x 168 x 218 mm
Weight	24 lbs (10.7 kg)
Terminal Type	M8
Case Material	ABS
Enclosure Protection	IP65
Cell Type - Chemistry	LiFePO ₄

CHARGE SPECIFICATIONS

Recommended Charge Current	37.5 A
Maximum Charge Current	75 A
Recommended Charge Voltage	14.2 V - 14.6 V
Reconnect Voltage	15.2 V
Balancing Voltage	14.4 V
Active Balance Current:	1-3A

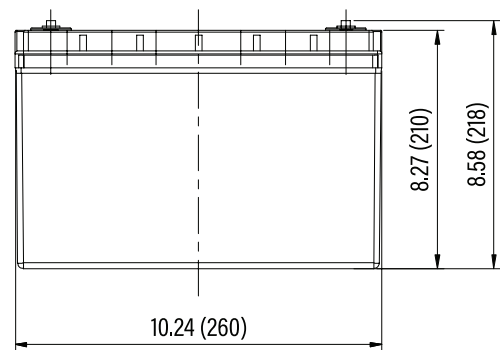

PERFORMANCE CHARACTERISTICS

Different Rate Discharge Curve @25°C

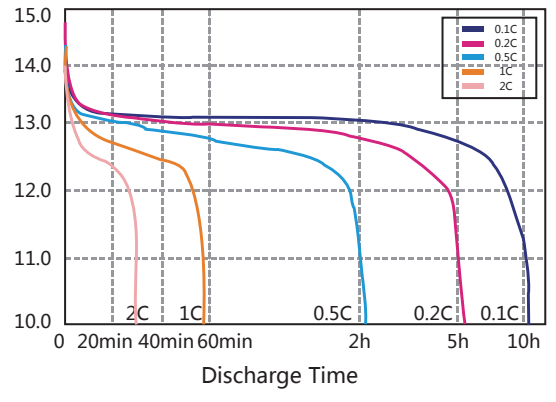

Different Temperature Discharge Curve @0.5°C

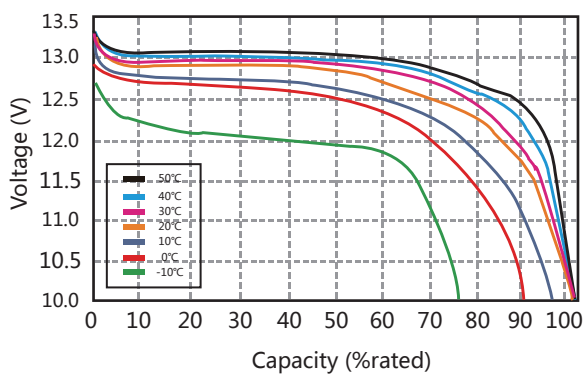

Charging Characteristics @0.5C 25°C

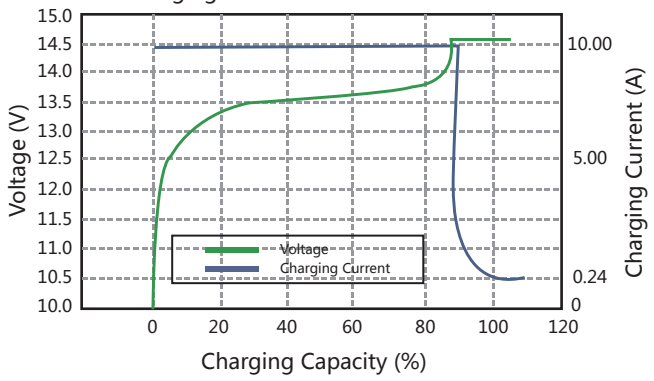

Different DoD Discharge Cycle Life @1C

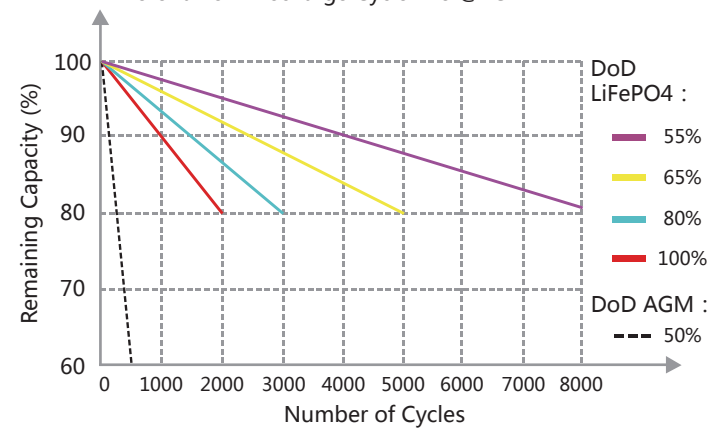

State of Charge Curve @0.5C 25°C

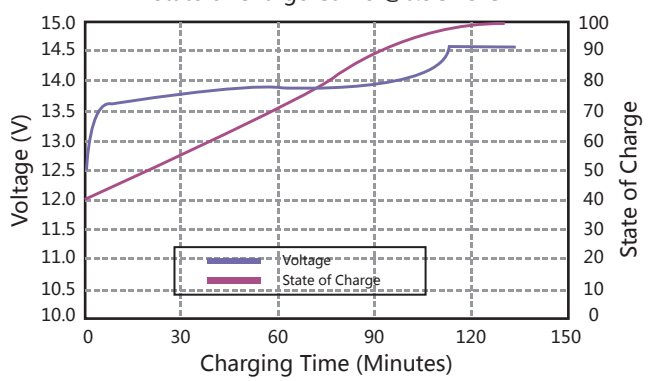

Different Temperature Self Discharge Curve

